

# ПОИСК ДВОЙНОГО БЕТА РАСПАДА В ЭКСПЕРИМЕНТЕ EXO-200

А.А. Буренков (ИТЭФ)



# Outline

- ▣ Double beta decay (briefly)
- ▣ EXO-200 (R&D and current status)
- ▣ First physics result from EXO-200, observation of the  $^{136}\text{Xe } 2\nu\beta\beta$ .



M. Goeppert-Mayer,  
Phys. Rev. 48  
(1935) 512

# Double beta decay

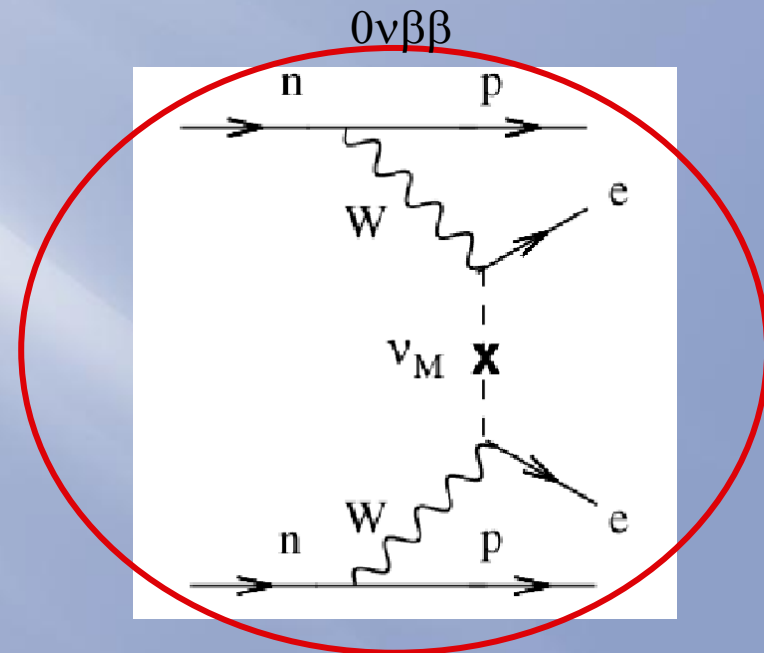
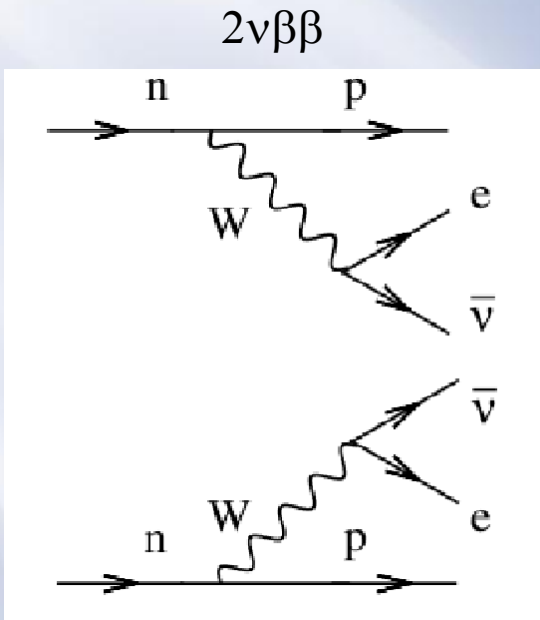

**This process can only occur  
for a Majorana neutrino!**

$$m_\nu \neq 0, \bar{\nu} = \nu$$

# Double beta decay

*a second-order process only detectable if first order beta decay is energetically forbidden*

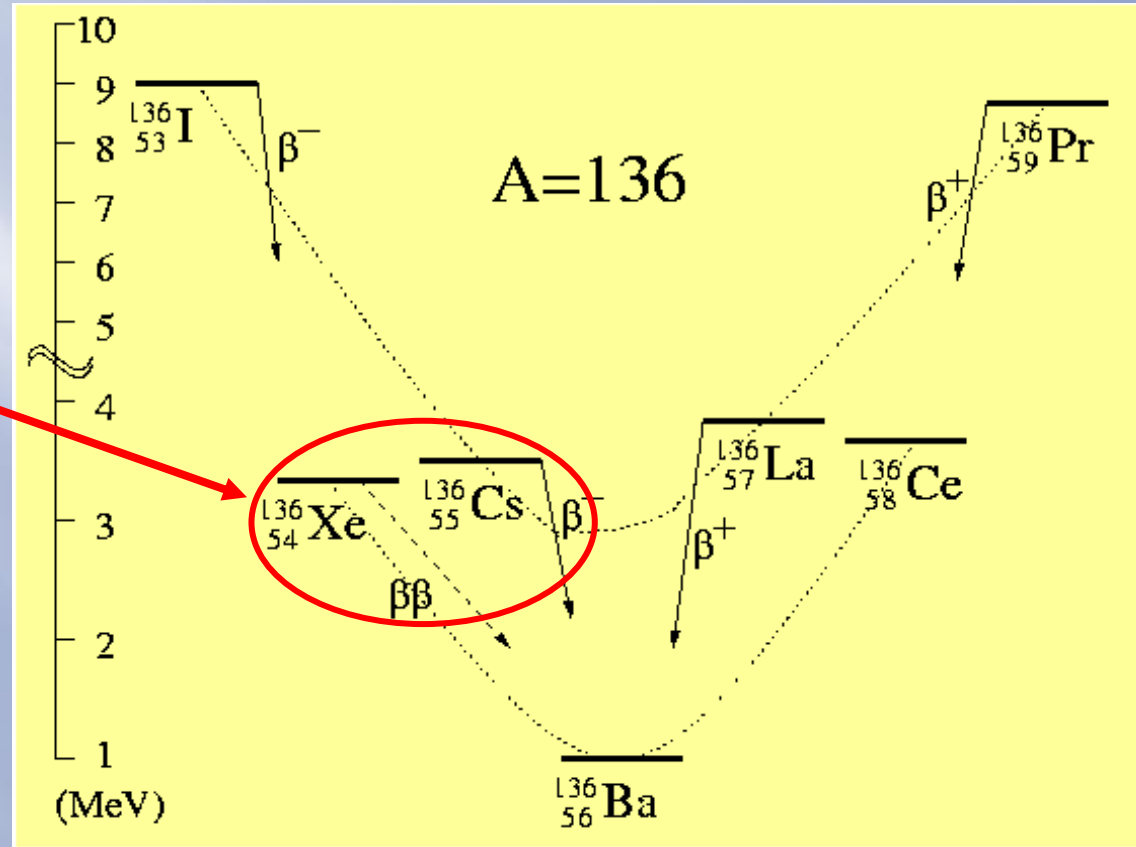

Atomic number ( $Z$ )

Some candidate nuclei:  $^{76}\text{Ge}$ ,  $^{82}\text{Se}$ ,  $^{100}\text{Mo}$ ,  $^{130}\text{Te}$ ,  $^{136}\text{Xe}$

# Double beta decay

**$2\nu\beta\beta$  spectrum  
(normalized to 1)**

**$0\nu\beta\beta$  peak (5% FWHM)  
(normalized to  $10^{-6}$ )**

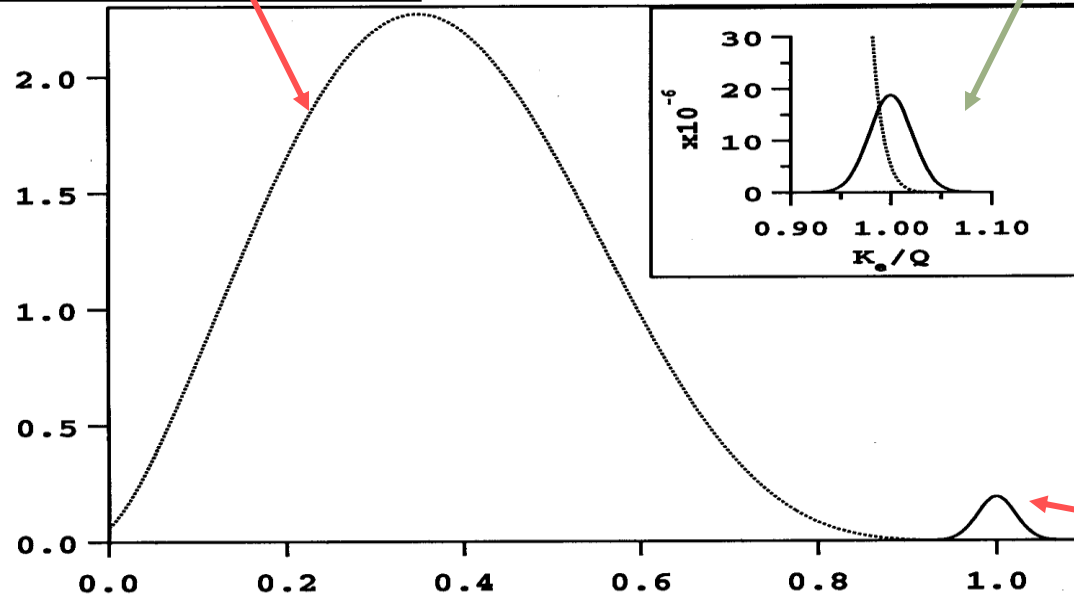

Summed electron energy in units of the kinematic endpoint ( $Q$ )

The two can be separated in a detector with good energy resolution

# Double beta decay

Table of  $2\nu$  halfives and matrix elements with references

	$T_{1/2} (\text{y})$	$M^{2\nu}(\text{MeV}^{-1})$	
$^{48}\text{Ca}$	$(4.3^{+2.4}_{-1.1} \pm 1.4)\text{E}19$	$0.05 \pm 0.02$	Balysh, PRL <b>77</b> ,5186(1996)
$^{76}\text{Ge}$	$(1.74 \pm 0.01^{+0.18}_{-0.16})\text{E}21$	$0.13 \pm 0.01$	Doerr, NIMA <b>513</b> ,596(2003)
$^{82}\text{Se}$	$(9.6 \pm 0.3 \pm 1.0)\text{E}19$	$0.10 \pm 0.01$	Arnold, PRL <b>95</b> ,182302(2005)
$^{96}\text{Zr}$	$(2.35 \pm 0.14 \pm 0.16)\text{E}19$	$0.12 \pm 0.01$	Argyriades, NPA <b>847</b> ,168(2010)
$^{100}\text{Mo}$	$(7.11 \pm 0.02 \pm 0.54)\text{E}18$	$0.23 \pm 0.01$	Arnold, PRL <b>95</b> ,182302(2005)
$^{116}\text{Cd}$	$(2.9^{+0.4}_{-0.3})\text{E}19$	$0.13 \pm 0.01$	Danevich, PRC <b>68</b> ,035501(2003)
$^{128}\text{Te}^*$	$(1.9 \pm 0.1 \pm 0.3)\text{E}24$	$0.05 \pm 0.005$	Lin, NPA <b>481</b> ,477(1988)
$^{130}\text{Te}$	$(7.0 \pm 0.9 \pm 1.1)\text{E}20$	$0.033 \pm 0.003$	Arnold, PRL <b>107</b> ,062504(2011)
$^{136}\text{Xe}$	$(2.1 \pm 0.04 \pm 0.21)\text{E}21$	$0.019 \pm 0.001$	Ackerman, arxiv:1108.4193(2011)
$^{150}\text{Nd}$	$(9.11^{+0.25}_{-0.22} \pm 0.63)\text{E}18$	$0.06 \pm 0.003$	Argyriades, PRC <b>80</b> ,032501R(2009)
$^{238}\text{U}^{**}$	$(2.2 \pm 0.6)\text{E}21$	$0.05 \pm 0.01$	Turkevich, PRL <b>67</b> ,3211(1991)

\*from geochemical ratio  $^{128}\text{Te}/^{130}\text{Te}$ ; \*\*radiochemical result



# The EXO collaboration



**University of Alabama, Tuscaloosa AL, USA**  
D. Auty, M. Hughes, R. MacLellan, A. Piepke,  
K. Pushkin, M. Volk

**University of Bern, Switzerland**  
M. Auger, S. Delaquis, D. Franco, G. Giroux,  
R. Gornea, T. Tolba, J-L. Vuilleumier, M.  
Weber

**California Institute of Technology, Pasadena  
CA, USA** - P. Vogel

**Carleton University, Ottawa ON, Canada**  
A. Coppens, M. Dunford, K. Graham, C.  
Hagemann, C. Hargrove, F. Leonard, C.  
Oullet, E. Rollin, D. Sinclair, V. Strickland

**Colorado State University, Fort Collins CO,  
USA**  
S. Alton, C. Benitez-Medina, C. Chambers,  
Adam Craycraft, S. Cook, W. Fairbank, Jr., K.  
Hall, N. Kaufold, T. Walton

**University of Illinois, Urbana-Champaign IL,  
USA** - D. Beck, J. Walton, L. Yang

**Indiana University, Bloomington IN, USA** - T.  
Johnson, L.J. Kaufman

**University of California, Irvine, Irvine CA, USA**  
- M. Moe

**ITEP Moscow, Russia** - D. Akimov, I.  
Alexandrov, V. Belov, A. Burenkov, M. Danilov,  
A. Dolgolenko, A. Karelin, A. Kovalenko, A.  
Kuchenkov, V. Stekhanov, O. Zeldovich

**Laurentian University, Sudbury ON, Canada**  
E. Beauchamp, D. Chauhan, B. Cleveland, J.  
Farine, B. Mong, U. Wichoski

**University of Maryland, College Park MD, USA**  
C. Davis, A. Dobi, C. Hall, S. Slutsky, Y-R. Yen

**University of Massachusetts, Amherst MA, USA**  
T. Daniels, S. Johnston, K. Kumar, A. Pocar, J.D.  
Wright

**University of Seoul, South Korea** - D. Leonard

**SLAC National Accelerator Laboratory, Menlo  
Park CA, USA**  
M. Breidenbach, R. Conley, R. Herbst, S. Herrin, J.  
Hodgson, A. Johnson, D. Mackay, A. Odian, C.Y.  
Prescott, P.C. Rowson, J.J. Russell, K. Skarpaas, M.  
Swift, A. Waite, M. Wittgen, J. Wodin

**Stanford University, Stanford CA, USA**  
P.S. Barbeau, T. Brunner, J. Davis, R. DeVoe, M.J.  
Dolinski, G. Gratta, M. Montero-Díez, A.R. Müller,  
R. Neilson, I. Ostrovskiy, K. O'Sullivan, A. Rivas, A.  
Sabourov, D. Tosi, K. Twelker

**Technical University of Munich, Garching,  
Germany**  
W. Feldmeier, P. Fierlinger, M. Marino

# Enriched Xenon Observatory (EXO)

EXO is a multi-phase program to search for the neutrinoless double beta decay of  $^{136}\text{Xe}$ .

EXO-200 (first phase):

A 200 kg liquid xenon detector currently operating underground  
Probe Majorana neutrino mass at 100-200 meV range  
Demonstrate technical feasibility of ton scale experiment

Full EXO (second phase):

A proposed 1- 10 ton liquid or gas xenon detector  
Probe Majorana neutrino mass at 5 – 30 meV range  
R&D work for novel techniques for background suppression and energy resolution in progress



# Xenon is an Excellent Candidate for $2\nu\beta\beta$ Search

**Xenon isotopic enrichment is easier.** Xe is already a gas &  $\text{Xe}^{136}$  is the heaviest isotope.

**Xenon is “reusable”.** Can be repurified & recycled into new detector (no crystal growth).

**Monolithic detector.** LXe is self shielding, surface contamination minimized.

**Minimal cosmogenic activation.** No long lived radioactive isotopes of Xe.

**Energy resolution in LXe can be improved.** Scintillation light/ionization correlation.

**... admits a novel coincidence technique.** Background reduction by Ba daughter tagging.

# EXO-200



Centrifuge facility in Russia



Enriched xenon storage bottles for EXO

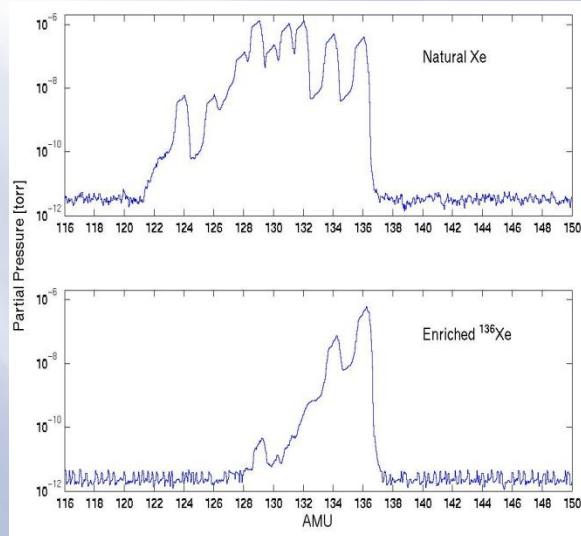

RGA mass scan of xenon samples

EXO collaboration currently have 200 kg of xenon enriched to 80% = 160 kg of <sup>136</sup>Xe

# EXO-200 Time Projection Chamber (TPC) Basics

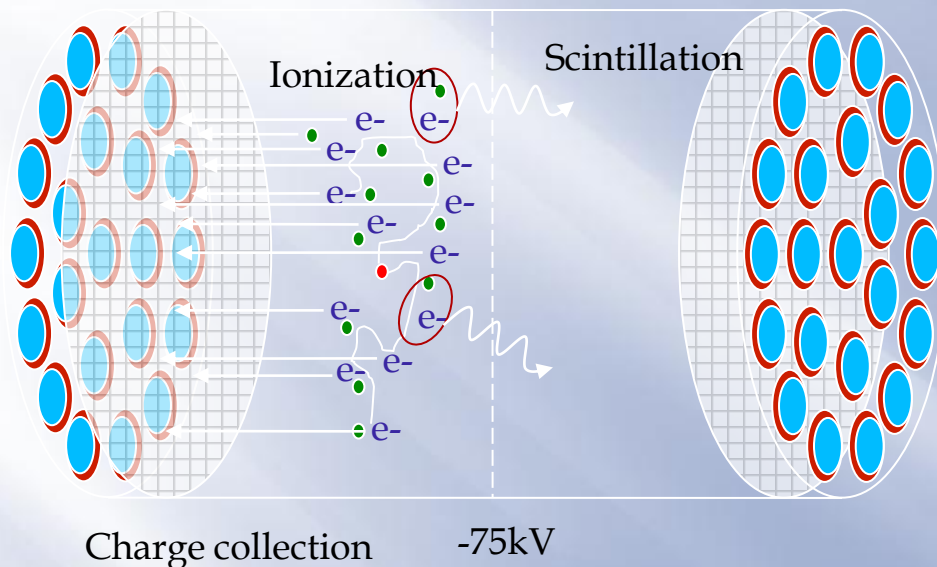

TPC Schematics

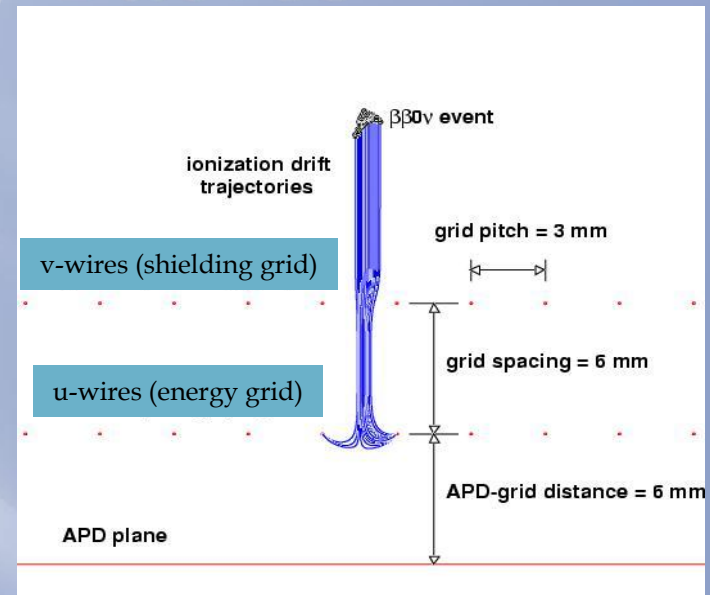

Simulation of Charge Drift

- Two TPC modules with common cathode in the middle.
- APD array observes prompt scintillation for drift time measurement.
- V-position given by induction signal on shielding grid.
- U-position and energy given by charge collection grid.



# Ultra-low activity Cu vessel



- Very light (~1.5mm thin, ~15kg) to minimize materials
- Different parts e-beam welded together
- Field TIG weld(s) to seal the vessel after assembly (TIG technology tested for radioactivity)
- All machining done by in the CR-shielded HEPL building)

# LAPD



APDs are ideal for our application:  
-very clean & light-weight,  
-very sensitive to VUV

QE > 1 at 175nm

R. Neilson, et al.  
NIM A 608 (2009) 6875

# The EXO-200 TPC

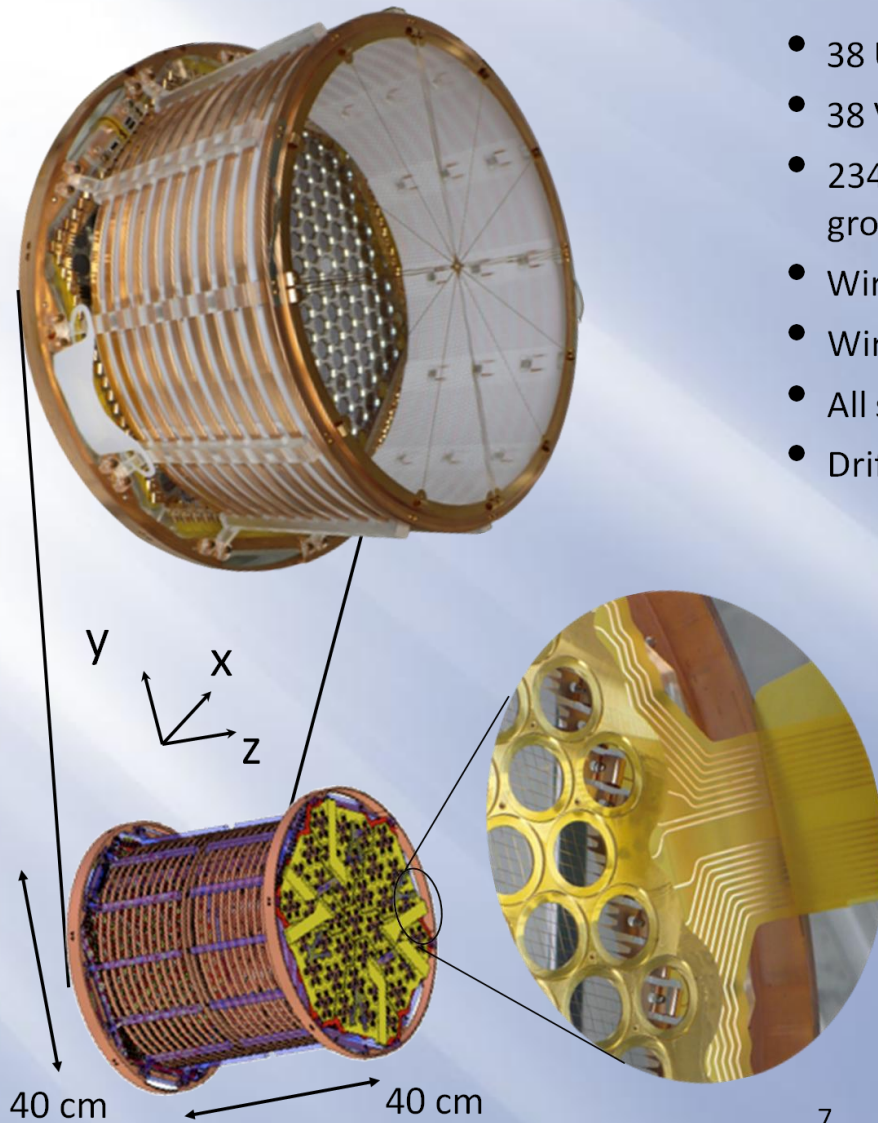

Two almost identical halves reading **ionization** and 178 nm **scintillation**, each with:

- 38 U triplet wire channels (charge)
- 38 V triplet wire channels, crossed at  $60^\circ$  (induction)
- 234 large area avalanche photodiodes (APDs, light in groups of 7)
- Wire pitch 3 mm (9 mm per channel)
- Wire planes 6 mm apart and 6 mm from APD plane
- All signals digitized at 1 MS/s,  $\pm 1024$ S around trigger
- Drift field 376 V/cm

- Field shaping rings: copper
- Supports: acrylic
- Light reflectors/diffusers: Teflon
- APD support plane: copper; Au (Al) coated for contact (light reflection)
- Central cathode, U+V wires: photo-etched phosphor bronze
- Flex cables for bias/readout: copper on kapton, no glue
- Comprehensive material screening program

• Goal: 40 cnts/2y in  $0\nu\beta\beta \pm 2\sigma$  ROI, 140 kg LXe

# EXO-200 TPC Assembled

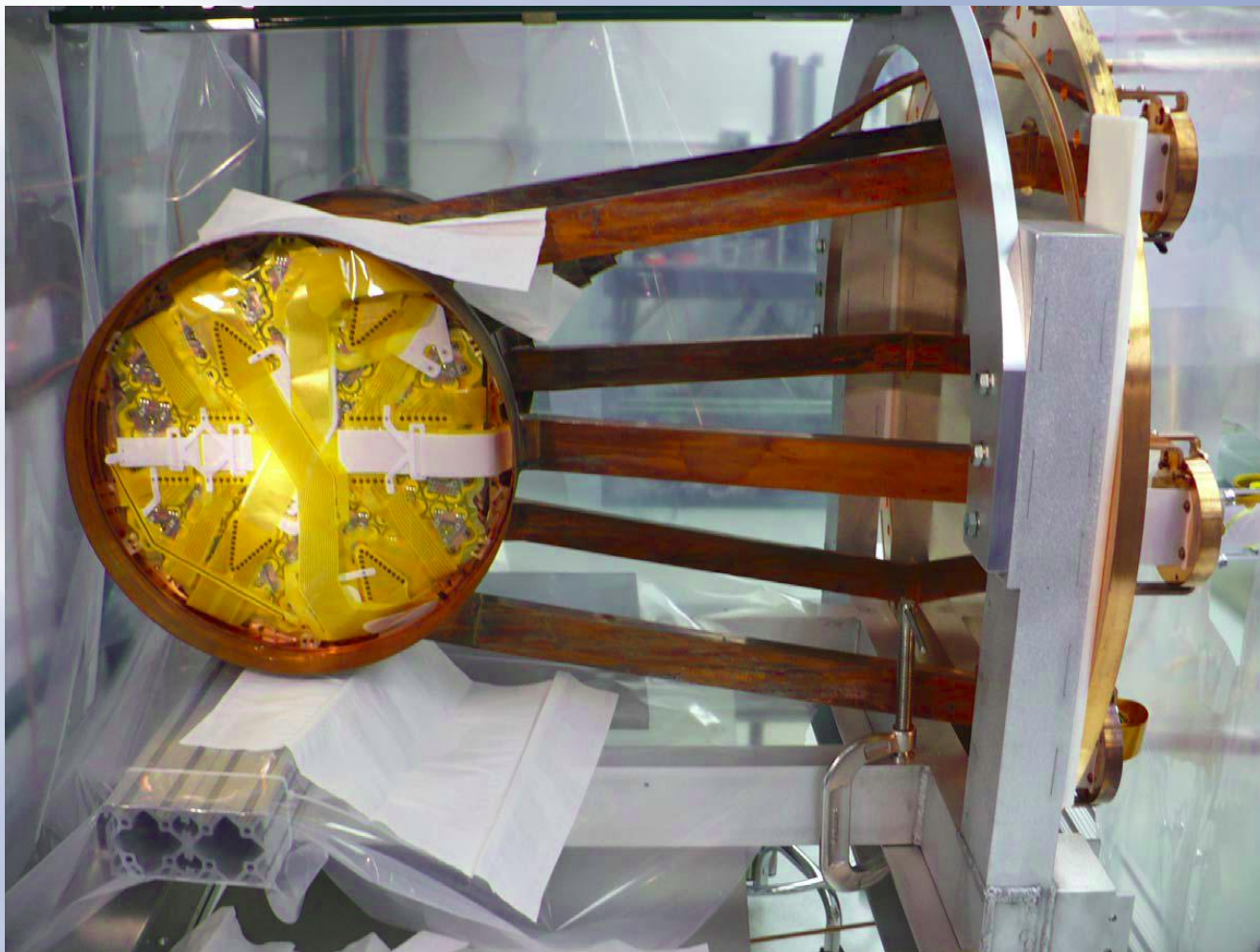





Copper vessel 1.37 mm thick  
175 kg LXe, 80.6% enr. in  $^{136}\text{Xe}$

Copper conduits (6) for:

- APD bias and readout cables
- U+V wires bias and readout
- LXe supply and return

Epoxy feedthroughs at cold and warm doors

Dedicated HV bias line

EXO-200 detector: JINST 7 (2012) P05010  
Characterization of APDs: NIM A608 68-75 (2009)  
Materials screening: NIM A591, 490-509 (2008)

# Underground location: Waste Isolation Pilot Plant (WIPP) Carlsbad, NM

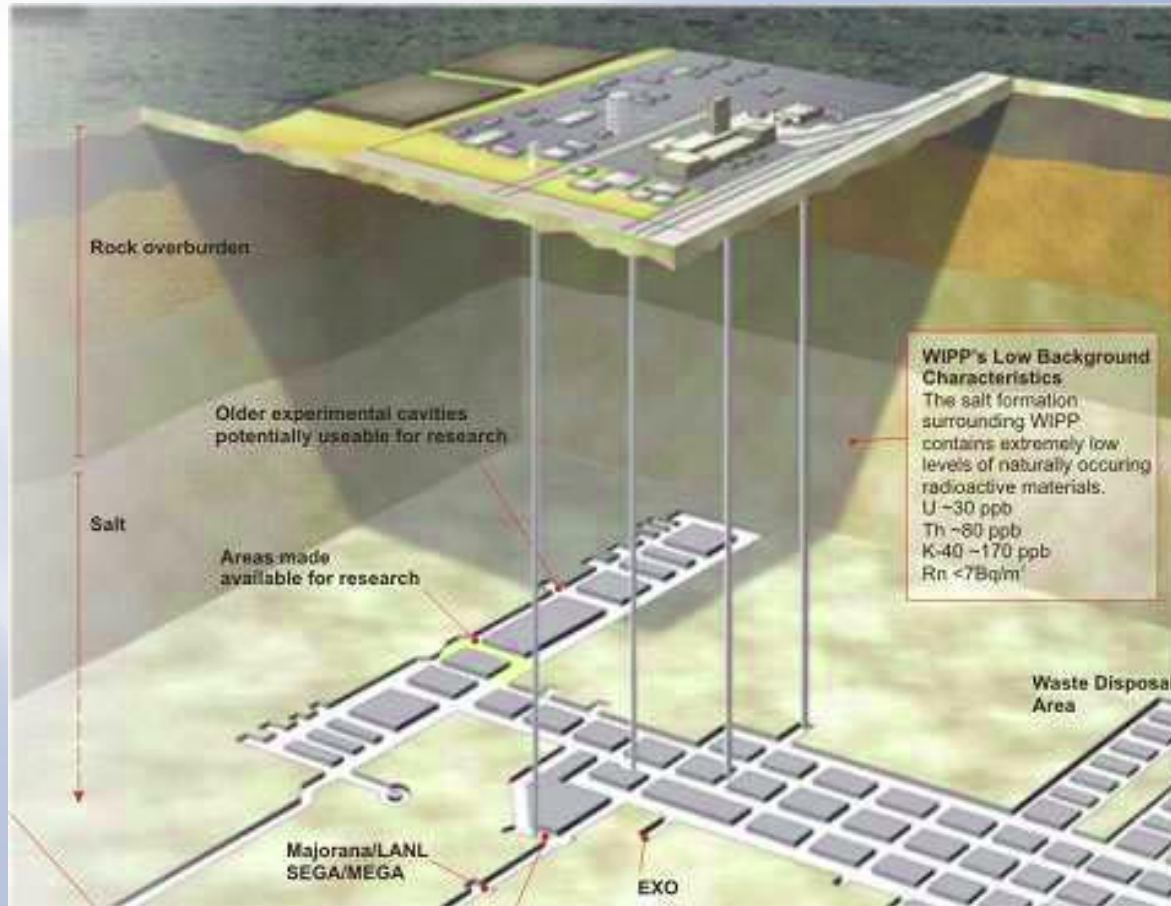

- ~1600 meter water equivalent flat overburden
- Relatively low levels of U and Th (<100 ppb in EXO-200 drift)
- Low levels of Rn (~20 Bq/m<sup>3</sup>)
- Rather convenient access with large conveyance

# EXO-200 detector

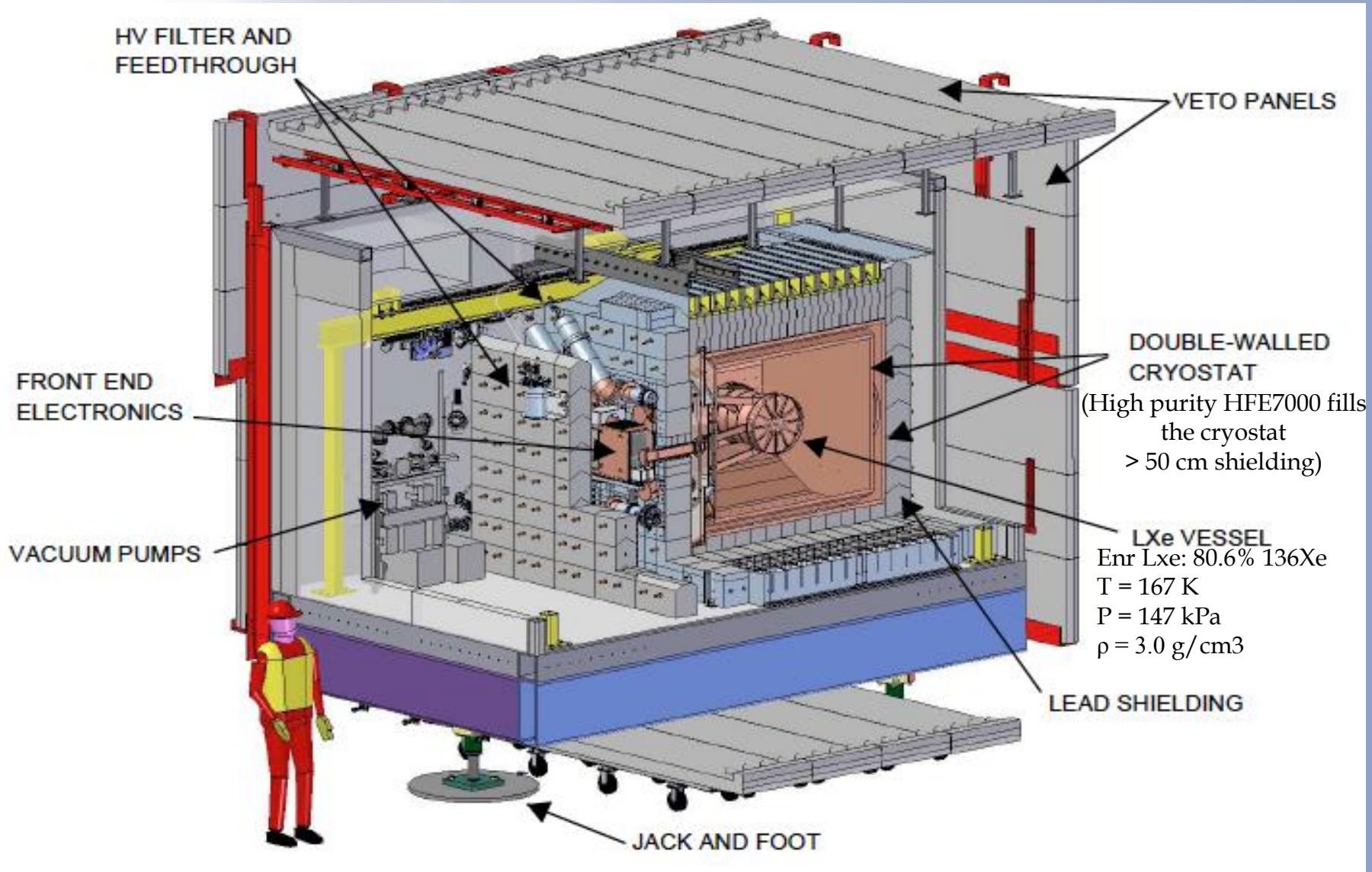



## Muon veto

50 mm thick plastic scintillator panels surrounding TPC on four sides.

$95.5 \pm 0.6$  % efficiency

Veto cuts (8.6% combined dead time)

- 25 ms after muon veto hit
- 60 s after muon track in TPC
- 1 s after every TPC event

# Data taking phases and xenon

	Run I	Run 2 (this analysis)
Period	May 21, 11 – Jul 9, 11	Sep 22, 11 – Apr 15, 12
Live Time	752.7 hr	2,896.6 hr
Exposure ( $^{136}\text{Xe}$ )	4.4 kg-yr	26.3 kg-yr
Publ.	PRL 107 (2011) 212501	arXiv:1205:5608

Sep 2011 – Hardware upgrades

- APD gain increase by factor 2
- improved U-wire shaping
- added outer lead shield

## Purity

Xenon gas is forced through heated Zr getter by custom ultraclean pump.

Electron lifetime  $\tau_e$  is determined by measuring the attenuation of the ionization signal as a function of drift time for the full-absorption peak of gamma ray sources

For this analysis, the recirculation rate was increased to 14 slpm, leading to long electron lifetimes in the TPC

At  $\tau_e = 3$  ms:

- max. drift time  $\sim 110$   $\mu\text{s}$
- loss of charge is 3.6% at full drift length

Ultraclean pump:

Rev Sci Instrum. 82(10):105114

Xenon purity with mas spectroscopy:

NIM A675 (2012) 40-46

Gas purity monitors:

NIM A659 (2011) 215-228

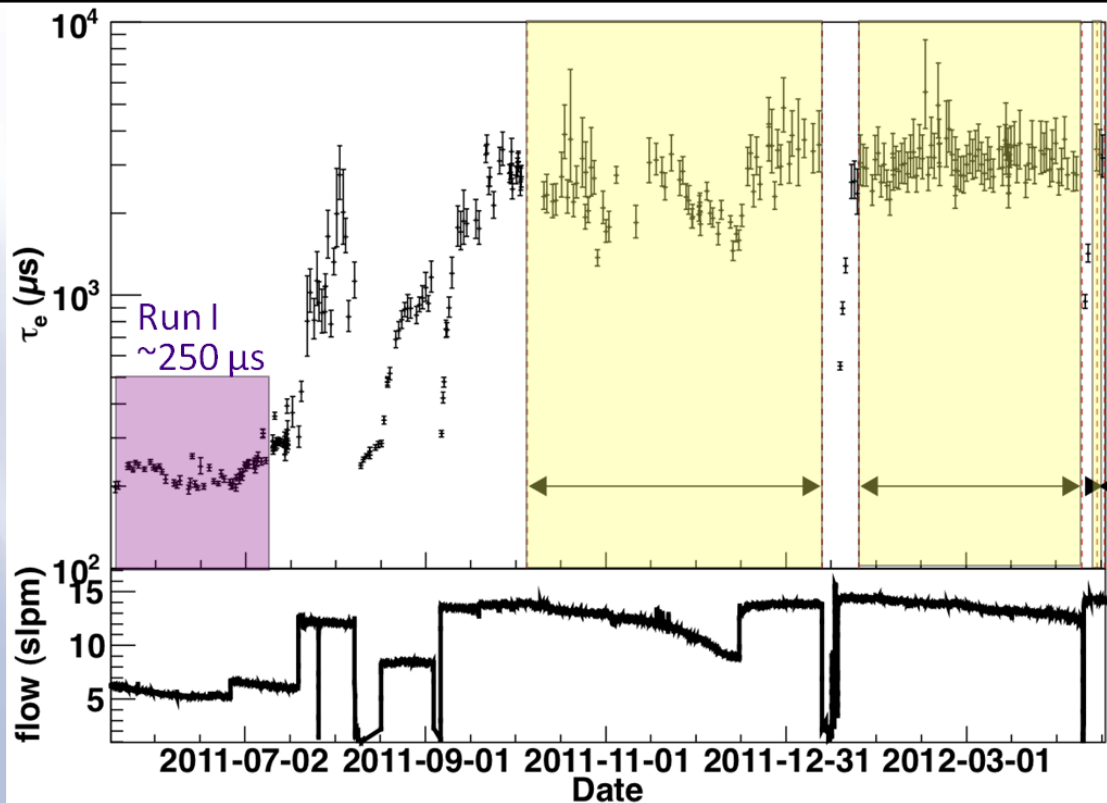

# Data taking phases and xenon

	Run I	Run 2 (this analysis)
Period	May 21, 11 – Jul 9, 11	Sep 22, 11 – Apr 15, 12
Live Time	752.7 hr	2 896.6 hr

- Sep 2011 – Hardware upgrades
- APD gain increase by factor 2
  - improved U-wire shaping
  - added outer lead shield

Run I Results:

$$T_{1/2}^{2\nu\beta\beta}(^{136}\text{Xe}) = (2.11 \pm 0.04 \text{ stat} \pm 0.21 \text{ sys}) \cdot 10^{21} \text{ yr}$$

In disagreement with previously reported limits by

R. Bernabei et al. Phys. Lett. B 546 (2002) 23, and  
 Yu. M. Gavriljuk et al. , Phys. Atom Nucl. 69 (2006)

This was also a measurement of a nuclear matrix element of  $0.019 \text{ MeV}^{-1}$ , the smallest measured among the  $2\nu\beta\beta$  emitters

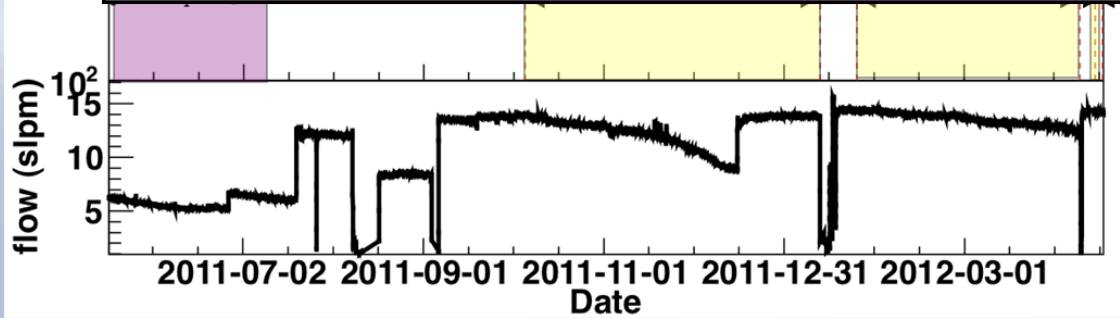

- max. drift time = 110 ps
- loss of charge is 3.6% at full drift length

Ultraclean pump:  
 Rev Sci Instrum. 82(10):105114  
 Xenon purity with mas spectroscopy:  
 NIM A675 (2012) 40-46  
 Gas purity monitors:  
 NIM A659 (2011) 215-228

h  
 imined  
 on of  
 unctio  
 orption  
 s  
 ulation  
 pm,  
 times

# Event reconstruction

- Signal finding – matched filters applied on U,V and APDs waveforms
- Signal parameter estimation (t, E) for charge and light
- Cluster finding – assignment to Single Site (SS) or Multiple Site (MS): resolution 18mm in X and Y and 6 mm in Z

Amplitudes corrected by channel for gain variation

Signal fitting functions use individual parameters for each channel

Optimized light correction using charge position

Charge corrected for inefficiency on small drift

Require events to be fully reconstructed in 3D

Reconstruction efficiency for  $0\nu\beta\beta$  is 71% – estimated by MC and verified by comparing the  $2\nu\beta\beta$  MC efficiency with low background data, over a broad range in energy

SS and MS spectra are fitted simultaneously with MC-generated probability density functions

# Anti-correlation between ionization and scintillation

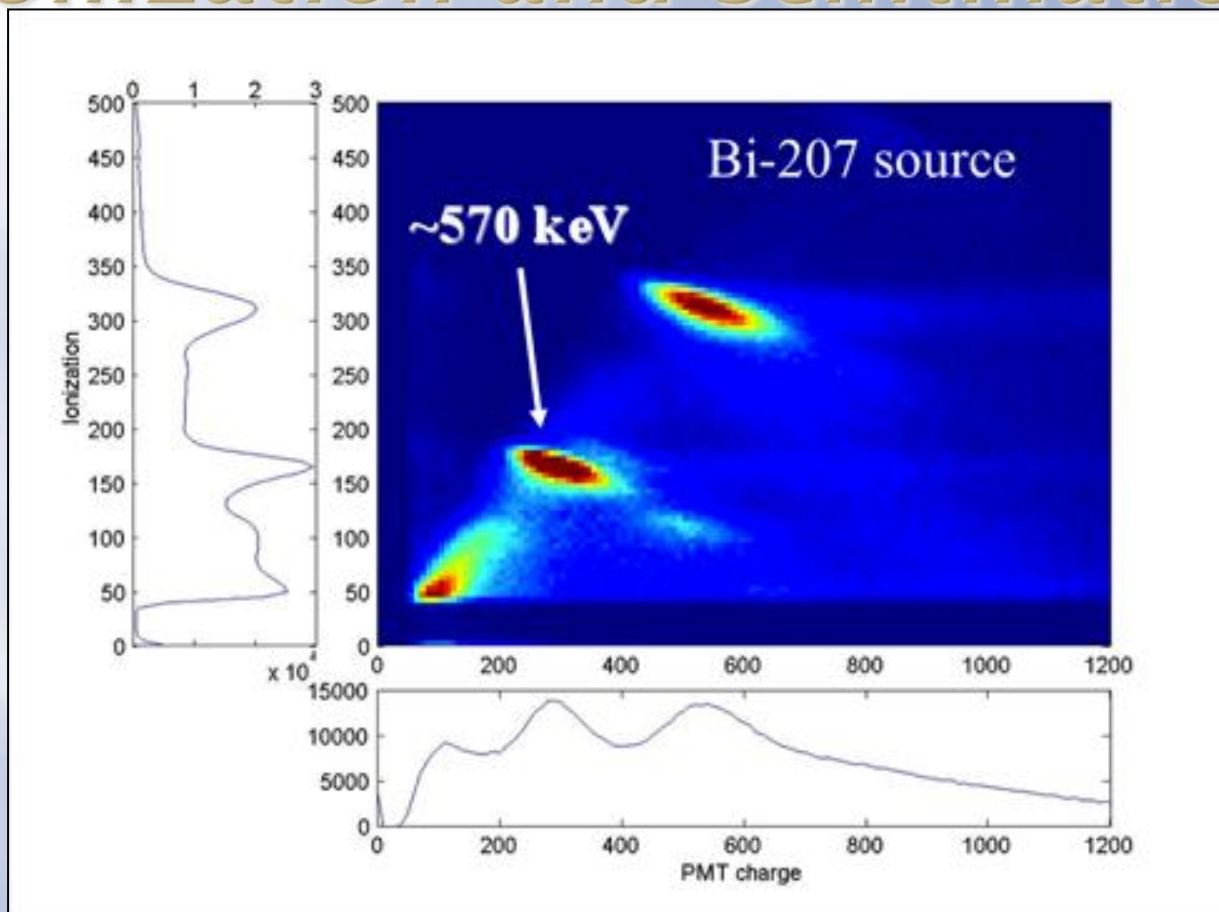

Ionization alone: 3.8% @ 570 keV or 1.8 % @  $Q(\beta\beta)$

Ionization & Scintillation: 3.0% @ 570 keV or 1.4 % @  $Q(\beta\beta)$

E.Conti et al., *Phys. Rev. B* 68 054201 (2003)



# Combining Ionization and Scintillation

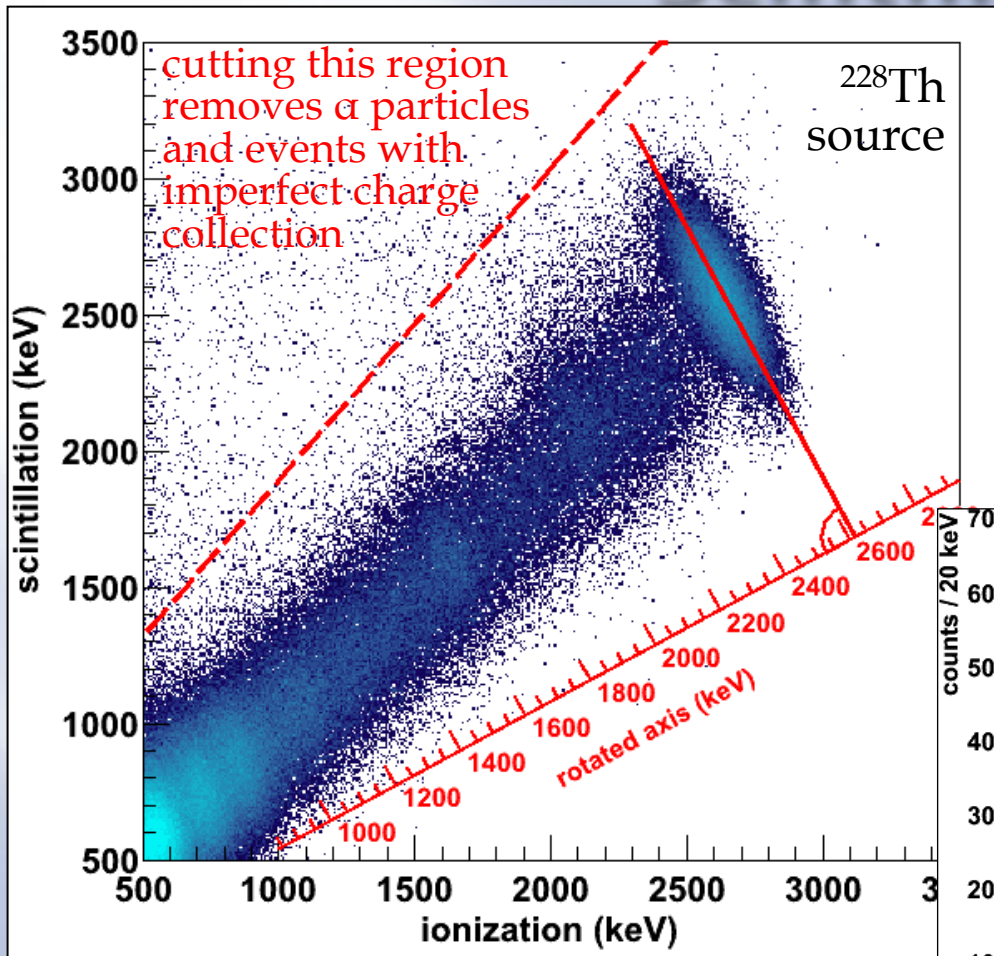

Properties of xenon cause increased scintillation to be associated with decreased ionization (and vice-versa)  
*E. Conti et al. Phys. Rev. B 68 (2003) 054201*  
Use projection onto a rotated axis to determine event energy

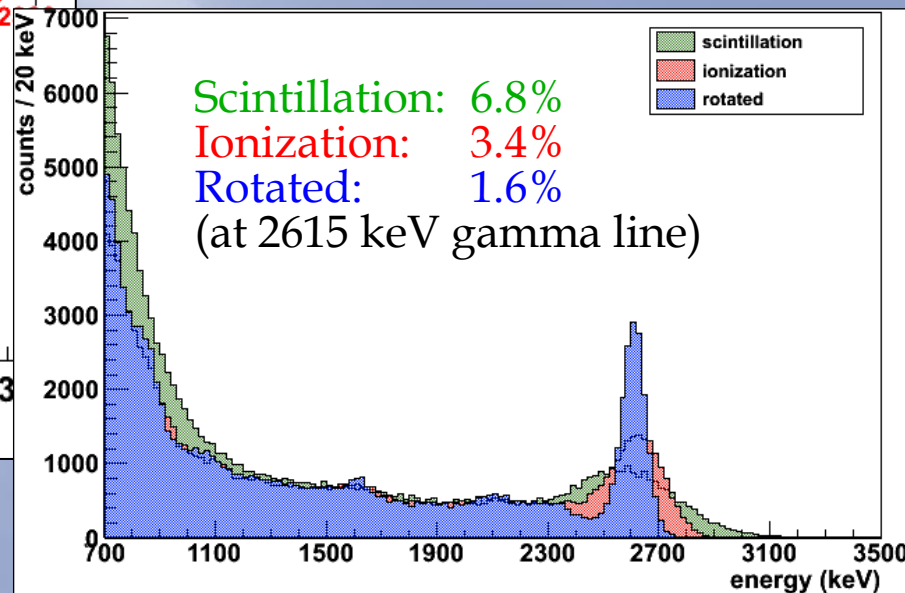

Rotation angle chosen to optimize energy resolution at 2615 keV

# Calibrations

## Miniaturized sources

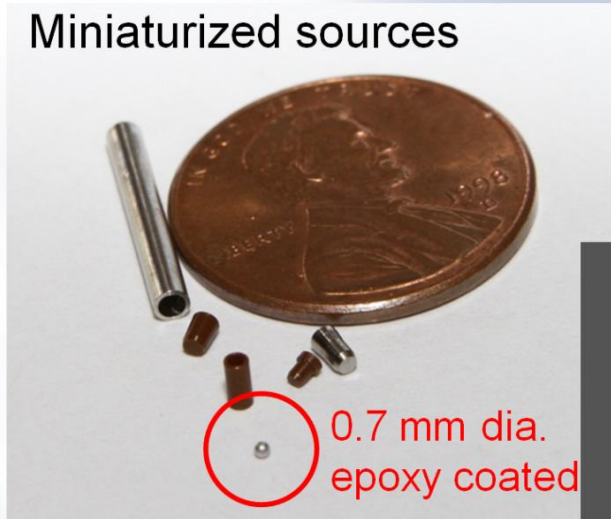

Source	Weak (kBq)	Strong (kBq)
60-Co	3.0	15.0
137-Cs	0.5	7.2
228-Th	1.5	38.0

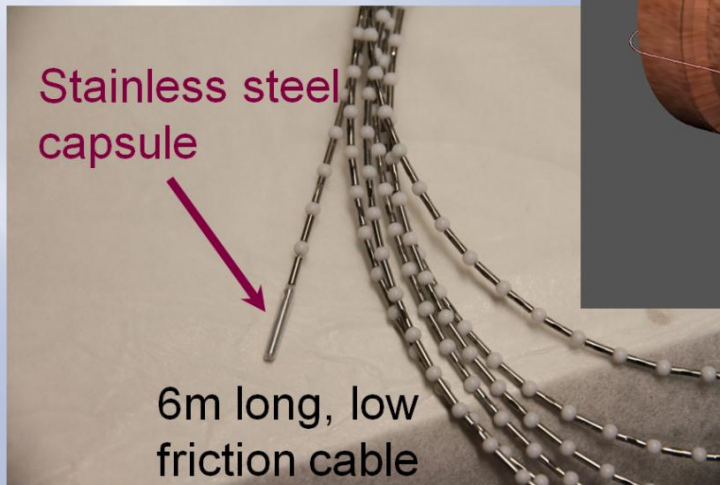
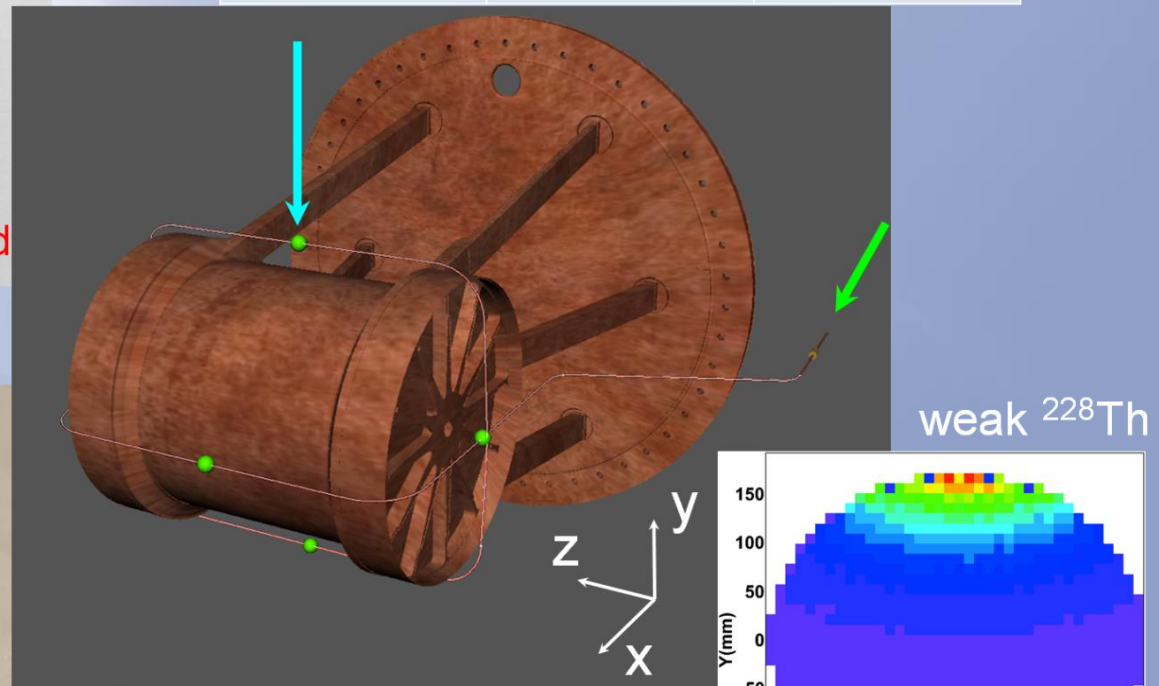

Provide 4 full energy deposition peaks in the energy range 662 keV – 2615 keV

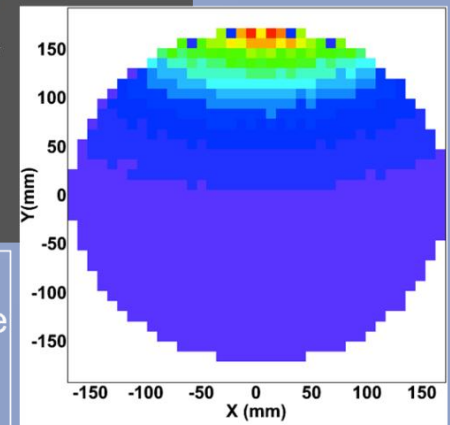

# $^{228}\text{Th}$ and $^{60}\text{Co}$ Source Shape

$^{228}\text{Th}$

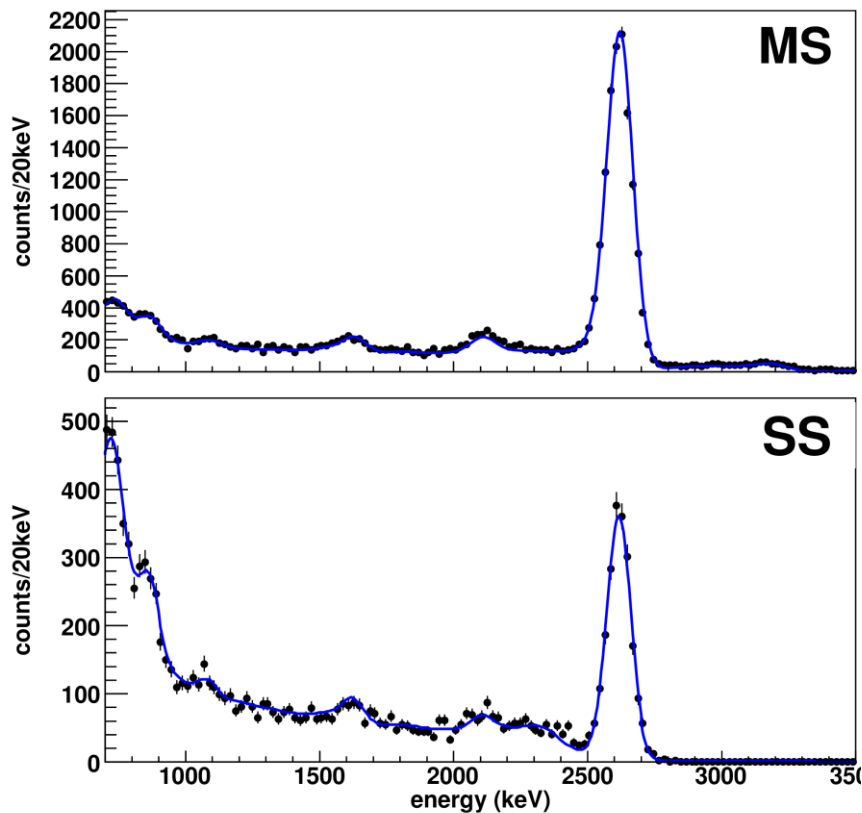

$^{60}\text{Co}$

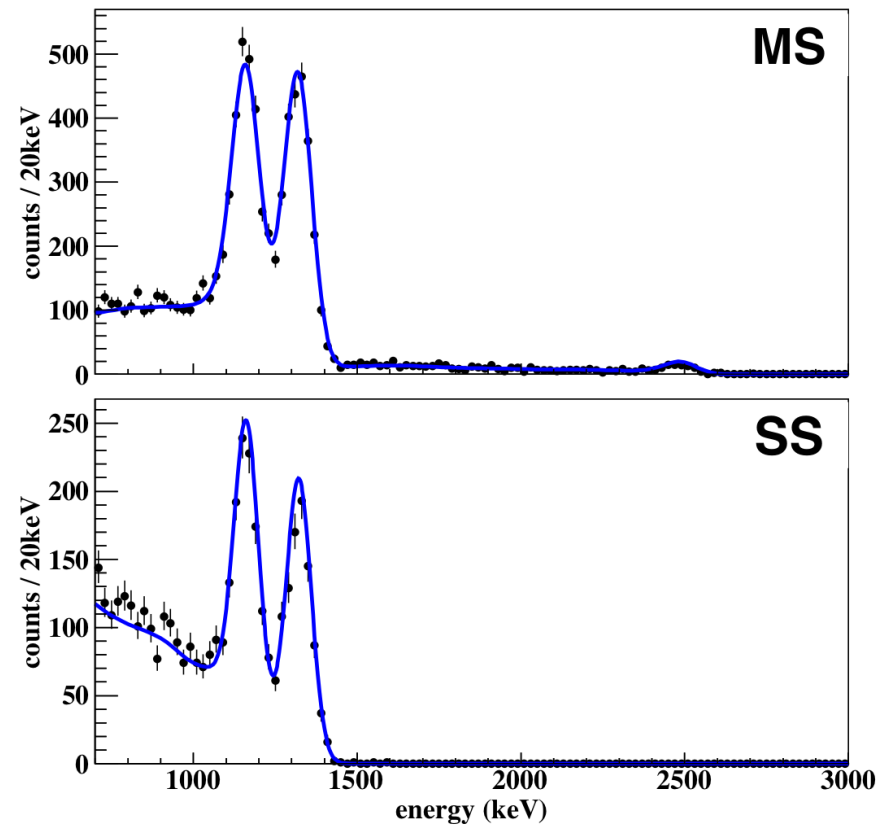

- Multi site (MS) and single site (SS) data (black points) are compared to model (blue curve)
- Single site fraction agrees to within 8.5%
- Can measure source activities to within 9.4%

# Energy Calibration

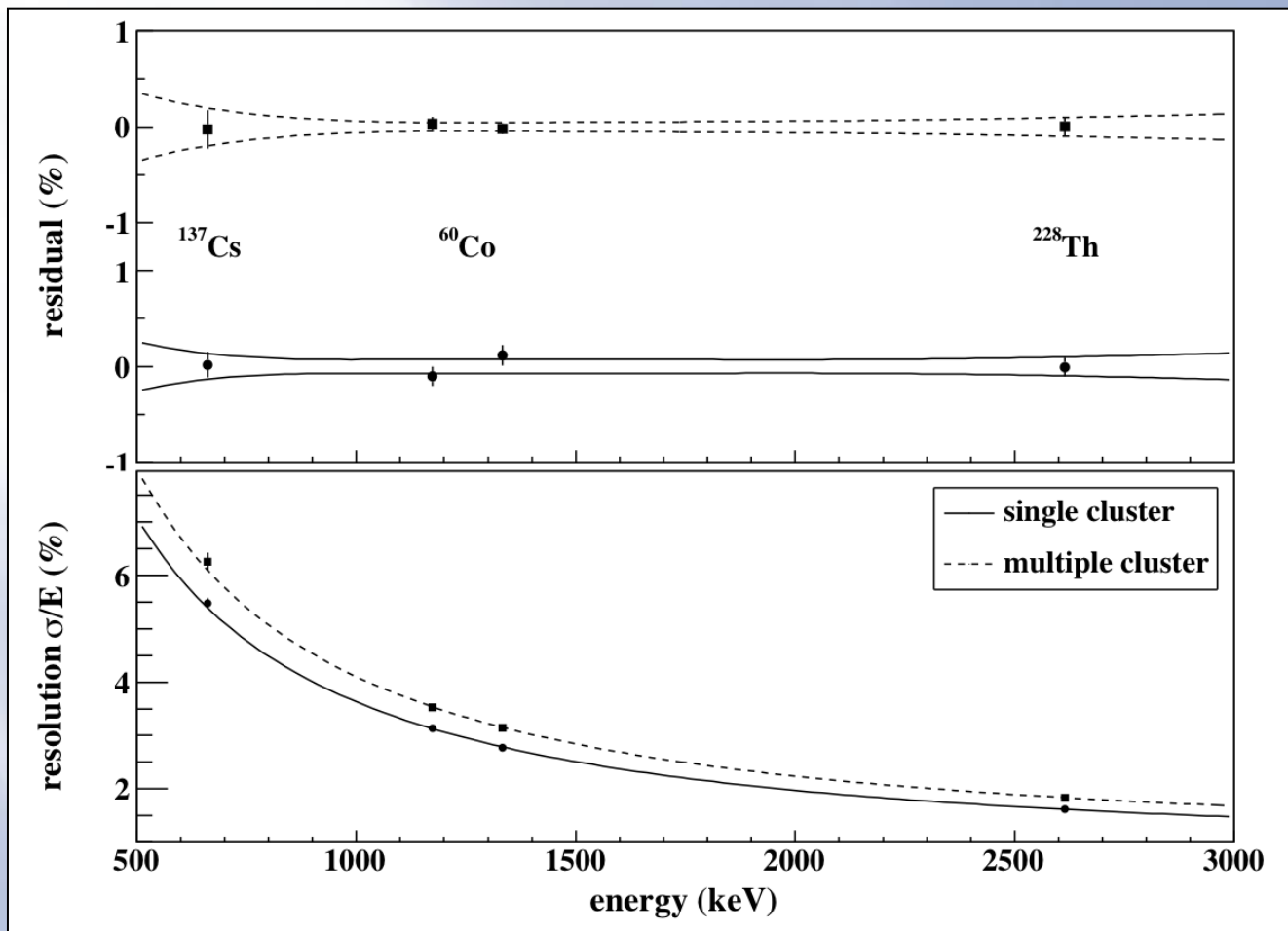

Using quadratic model for energy calibration, single- and multi-site residual are  $< 0.1\%$

Energy resolution model:

$$\sigma_{Tot}^2 = p_0^2 E + p_1^2 + p_2^2 E^2$$

Resolution dominated by constant (noise) term  $p_1$

At  $Q\beta\beta$  (2458 keV):  
 $\sigma/E = 1.67\%$  (SS)  
 $\sigma/E = 1.84\%$  (MS)

# Low background 2D SS spectrum

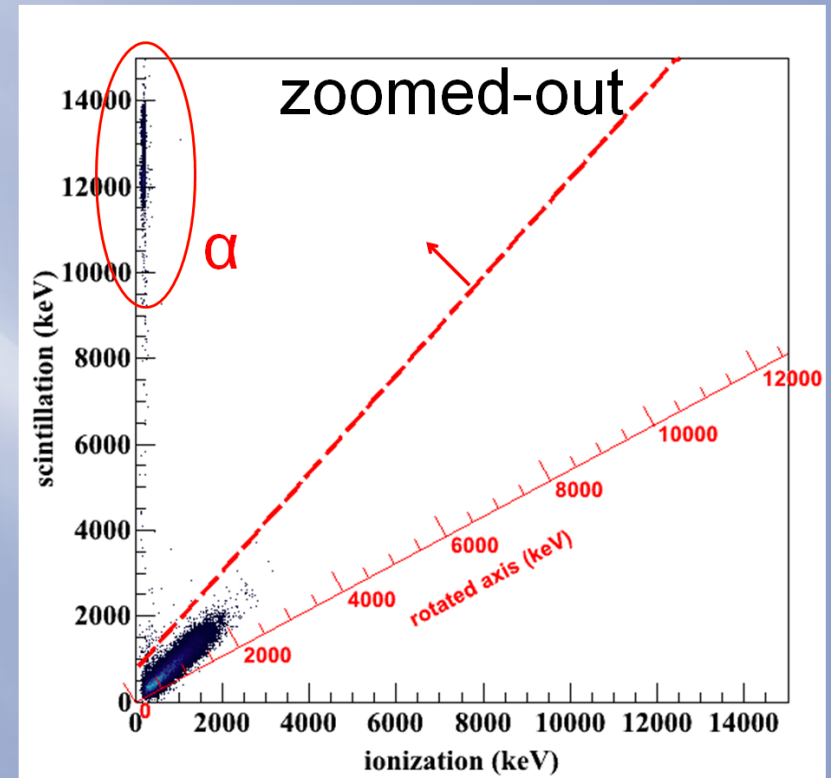
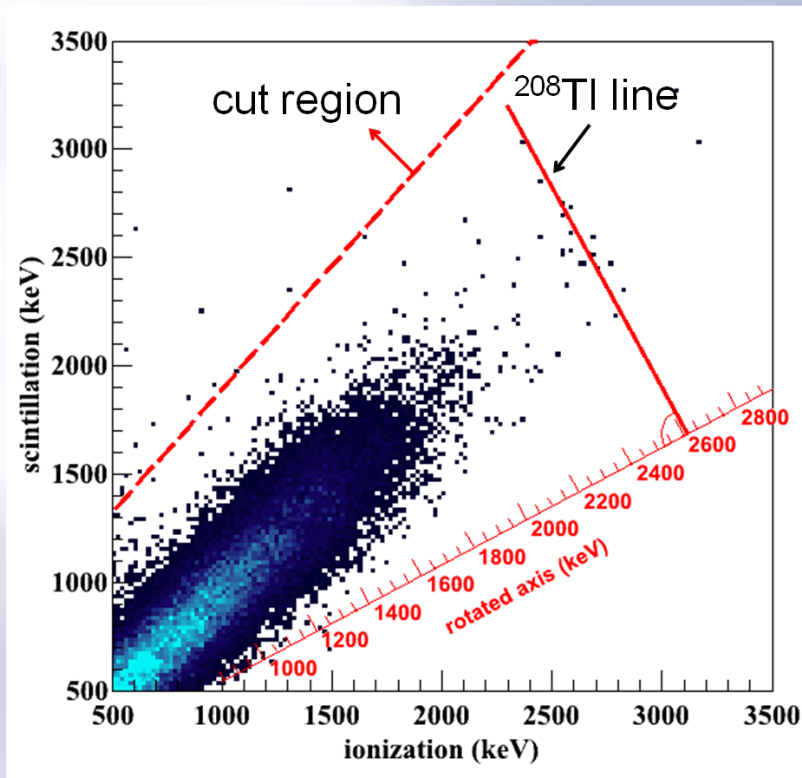

Events removed by diagonal cut:

- alpha events (they leave large ionization density, which leads to more recombination, which means more scintillation light) events near edge of detector, where not all the charge ends up on the collection wires

# Low Background Spectrum

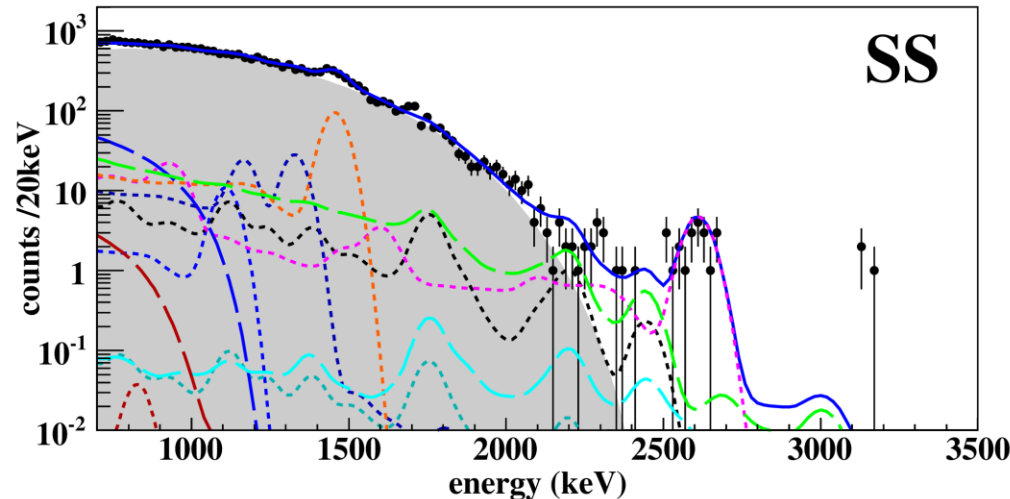
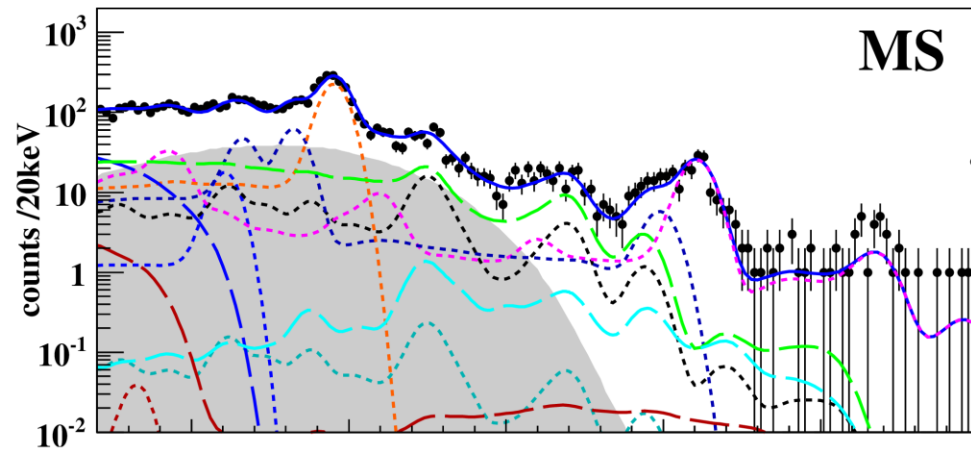

- Trigger fully efficient above 700 keV
- Low background run livetime: **120.7 days**
- Active mass: **98.5 kg LXe (79.4 kg  $^{136}\text{LXe}$ )**
- Exposure: **32.5 kg·yr**
- Total dead time (vetos): 8.6%
- Various background PDFs fitted along with  $2\nu\beta\beta$  and  $0\nu\beta\beta$  PDFs

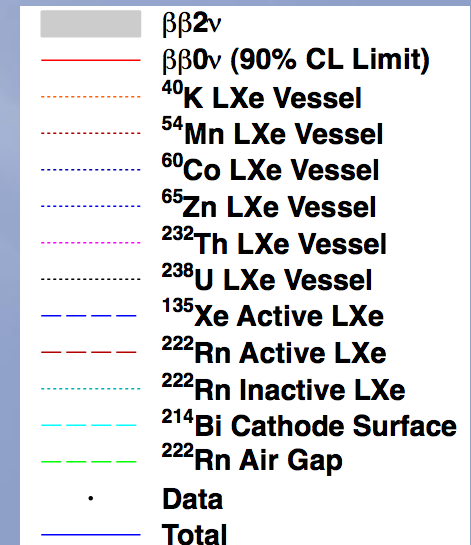

# Low Background Spectrum



- Trigger fully efficient above 700 keV
- Low background run livetime: **120.7 days**

$$T_{1/2}^{2\nu\beta\beta} (^{136}\text{Xe}) = (2.23 \pm 0.017 \text{ stat} \pm 0.22 \text{ sys}) \cdot 10^{21} \text{ yr}$$

In agreement with previously reported value by

EXO-200 Phys.Rev.Lett. 107 (2011) 212501

and

KamLAND-ZEN Phys.Rev.C85:045504,2012)

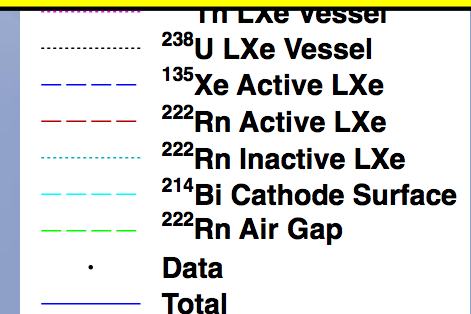
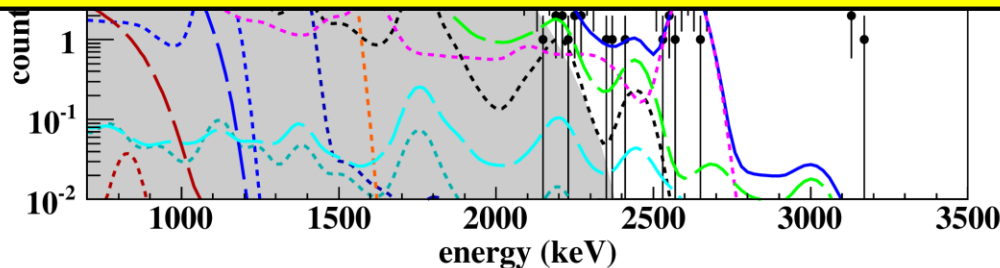

# Low Background Spectrum

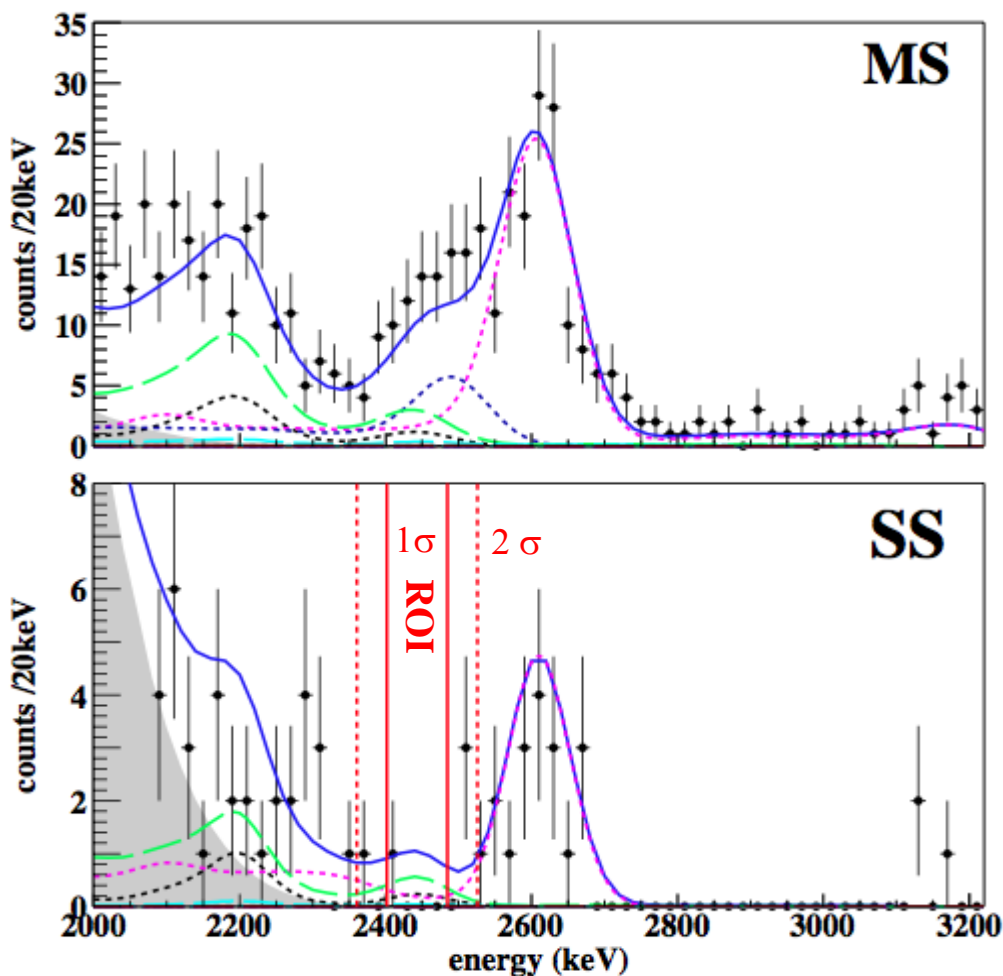

Profile likelihood fit to entire SS and MS spectra to extract limits for  $T_{1/2}^{0\nu\beta\beta}$

No  $0\nu$  signal observed

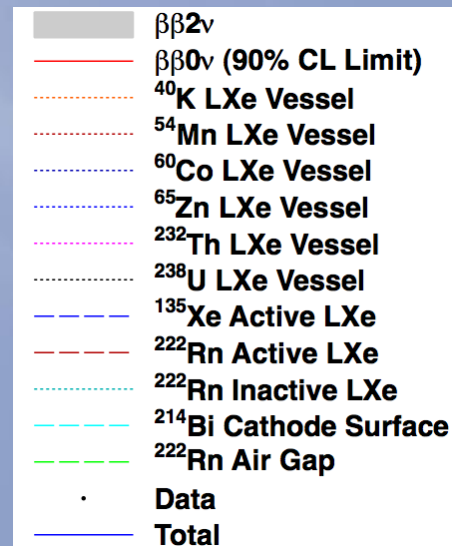



# Limits on $T_{1/2}^{0\nu\beta\beta}$ and $\langle m_{\beta\beta} \rangle$

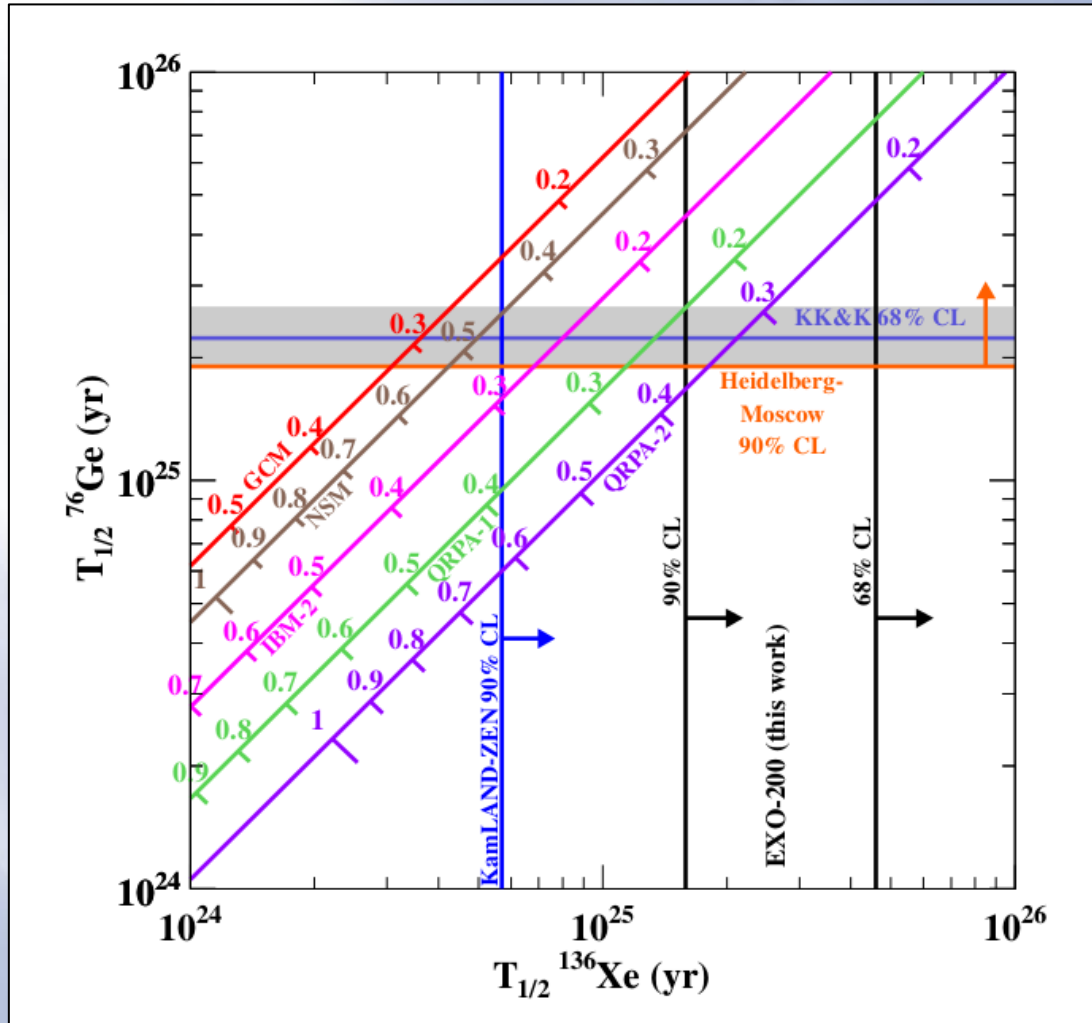

90% C.L. limit compared with Recent  $^{136}\text{Xe}$  constraints (KamLAND-ZEN) >2.5 factor improvement.

$$T_{1/2}^{0\nu\beta\beta} > 1.6 \cdot 10^{25} \text{ yr}$$

$$\langle m_{\beta\beta} \rangle < 140 - 380 \text{ mV} \quad (90\% \text{ C.L.})$$

[arXiv:1205.5608]

Tension with discovery claim in Ge.

KamLAND-Zen Collaboration  
 Phys. Rev. C 85 (2012) 045504  
 [H.V. Klapdor-Kleingrothaus et al.  
 Eur. Phys. J. A12 (2001) 147]  
 [H.V. Klapdor-Kleingrothaus and  
 I.V. Krivosheina  
 Mod. Phys. Lett., A21 (2006) 1547]

# Conclusions

- EXO-200 is taking low background data
- Detector working well, met our goals:
- Energy resolution: 1.67% at  $Q_{\beta\beta}$
- Background:  $1.5 \times 10^{-3} \text{ kg}^{-1}\text{keV}^{-1}\text{yr}^{-1}$
- 1 (5) counts in  $1\sigma$  ( $2\sigma$ )  $0\nu\beta\beta$  ROI

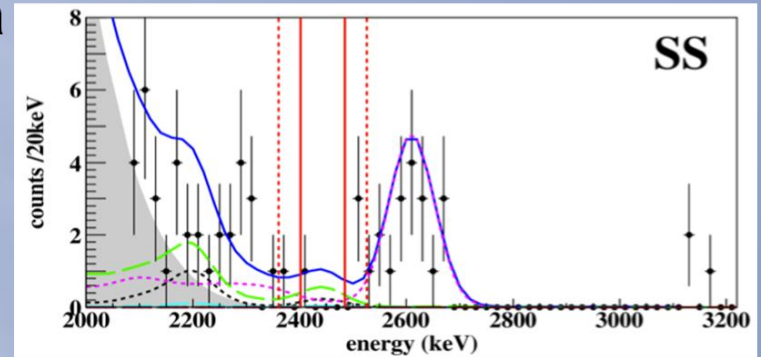

$$T_{1/2}^{0\nu\beta\beta} > 1.6 \cdot 10^{25} \text{ yr}$$

$$\langle m_{\beta\beta} \rangle < 140\text{--}380 \text{ meV}$$

(90% C.L.)

arXiv:1205.5608 – Subm. to PRL

- Improvements on  $\sigma$  and  $b$  in progress
- EXO-200 approved to run for 4 more years

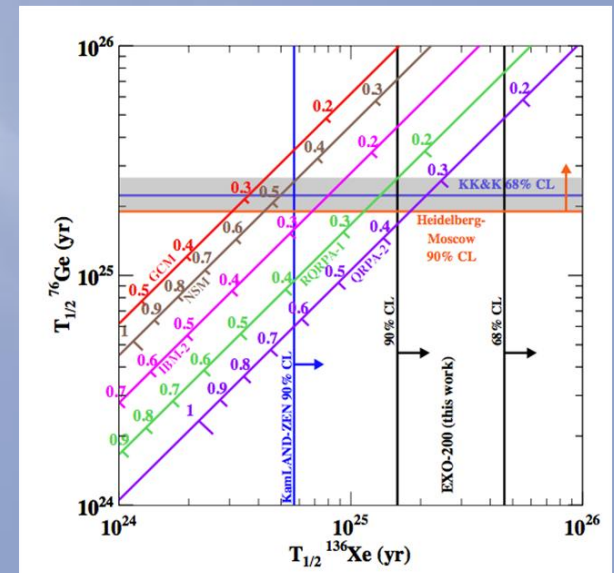

# Limit on Neutrinoless Decay of $^{136}\text{Xe}$ from the First Phase of KamLAND-Zen

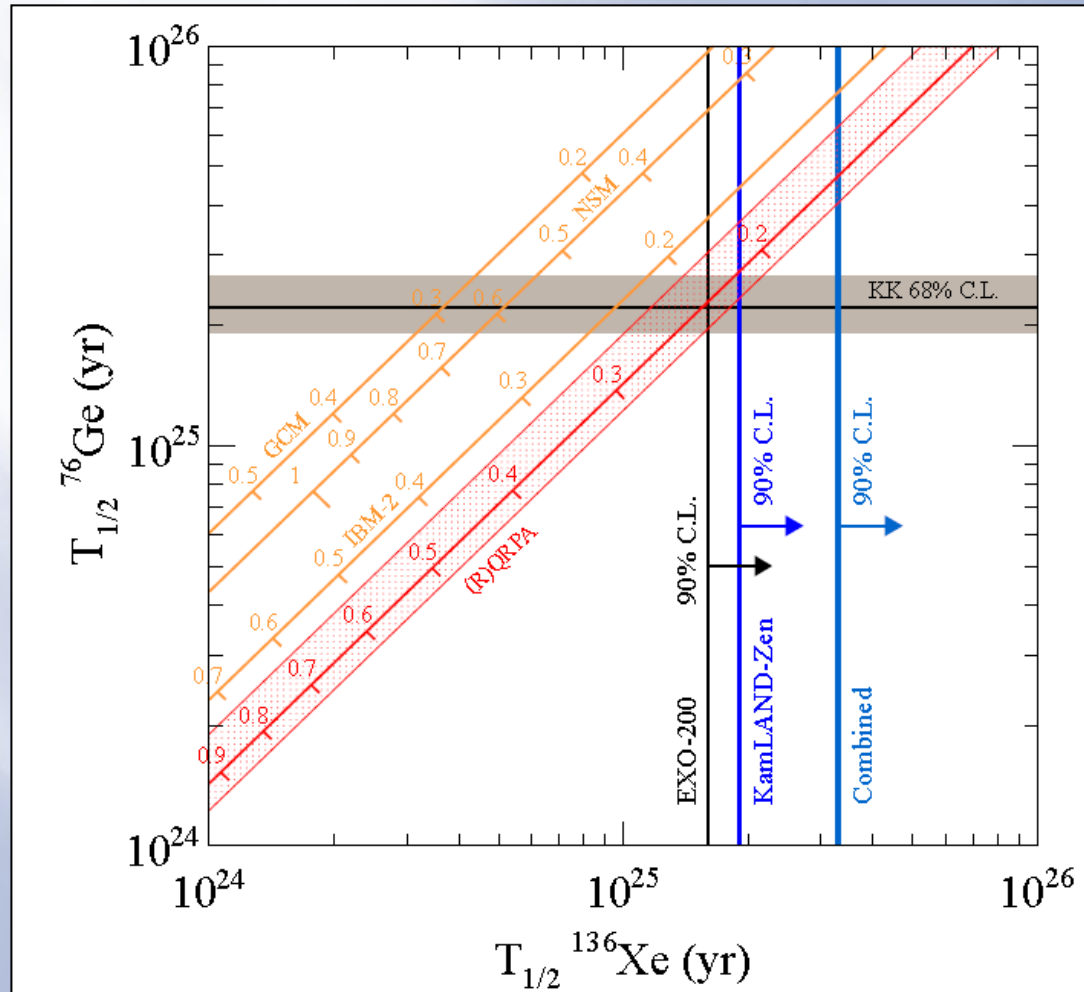

$T_{1/2}^{0\nu\beta\beta} > 1.9 \cdot 10^{25}$  yr  
combined

$T_{1/2}^{0\nu\beta\beta} > 3.4 \cdot 10^{25}$  yr  
 $\langle m_{\beta\beta} \rangle < 120 - 250$  mV  
(90% C.L.)

[arXiv:1211.3863]

89.5 kg-yr of  $^{136}\text{Xe}$